

# FUNDAMENTAL FORCES: RANGES, INTERACTION TIMES, CROSS SECTIONS

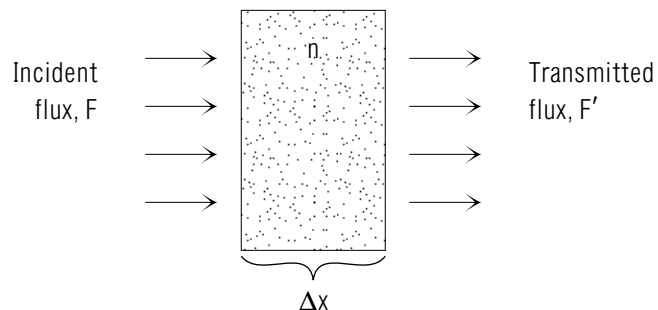

## FUNDAMENTAL FORCES: RANGES, INTERACTION TIMES, CROSS SECTIONS

by

J. S. Kovacs and William C. Lane

<b>1. Introduction</b> .....	1
<b>2. Characteristic Force Ranges</b>	
a. The Range of the Strong Interaction .....	1
b. The Range of the Weak Interaction .....	2
c. The Range of the Electromagnetic Interaction .....	2
<b>3. Characteristic Interaction Times</b>	
a. Characteristic Time for Strong Interactions .....	2
b. Characteristic Time for Weak Interactions .....	2
c. Characteristic Time of Electromagnetic Interactions .....	3
<b>4. Reaction Cross Sections</b>	
a. Introduction .....	4
b. Definition of Cross Sections .....	5
c. Flux of Particles .....	5
d. Relation Between Flux and Cross Section .....	5
<b>Acknowledgments</b> .....	7
<b>Glossary</b> .....	7

Title: **Fundamental Forces: Ranges, Interaction Times, Cross Sections**

Author: J.S.Kovacs and William C.Lane, Michigan State University

Version: 1/22/2001 Evaluation: Stage 0

Length: 1 hr; 16 pages

**Input Skills:**

1. Vocabulary: electromagnetic interaction, elementary particle, fundamental force, hadron, meson, muon, neutrino, nucleons, strong interaction, weak interaction (MISN-0-255).
2. Integrate functions such as  $x$  and  $1/x$  (MISN-0-1).

**Output Skills (Knowledge):**

- K1. Vocabulary: cross section, flux, total cross section, intermediate vector boson.
- K2. State the characteristic times associated with the strong, weak and electromagnetic interactions among elementary particles.
- K3. State the characteristic ranges associated with the strong and weak interactions.

**Output Skills (Problem Solving):**

- S1. Determine the fractional number of strong (or weak) interactions that can occur in an interaction in which the target particle density is given.
- S2. Given the target particle density and the fractional loss of projectile beam flux through the targets, calculate the total cross section for all reactions.

**Post-Options:**

1. "Conservation Laws for Elementary Particle Reactions" (MISN-0-256).

THIS IS A DEVELOPMENTAL-STAGE PUBLICATION  
OF PROJECT PHYSNET

The goal of our project is to assist a network of educators and scientists in transferring physics from one person to another. We support manuscript processing and distribution, along with communication and information systems. We also work with employers to identify basic scientific skills as well as physics topics that are needed in science and technology. A number of our publications are aimed at assisting users in acquiring such skills.

Our publications are designed: (i) to be updated quickly in response to field tests and new scientific developments; (ii) to be used in both classroom and professional settings; (iii) to show the prerequisite dependencies existing among the various chunks of physics knowledge and skill, as a guide both to mental organization and to use of the materials; and (iv) to be adapted quickly to specific user needs ranging from single-skill instruction to complete custom textbooks.

New authors, reviewers and field testers are welcome.

PROJECT STAFF

Andrew Schnepf	Webmaster
Eugene Kales	Graphics
Peter Signell	Project Director

ADVISORY COMMITTEE

D. Alan Bromley	Yale University
E. Leonard Jossem	The Ohio State University
A. A. Strassenburg	S. U. N. Y., Stony Brook

Views expressed in a module are those of the module author(s) and are not necessarily those of other project participants.

© 2001, Peter Signell for Project PHYSNET, Physics-Astronomy Bldg., Mich. State Univ., E. Lansing, MI 48824; (517) 355-3784. For our liberal use policies see:

<http://www.physnet.org/home/modules/license.html>.

# FUNDAMENTAL FORCES: RANGES, INTERACTION TIMES, CROSS SECTIONS

by

J. S. Kovacs and William C. Lane

## 1. Introduction

There are only three fundamental forces responsible for all interactions among elementary particles.<sup>1</sup> Each of these interactions (electromagnetic, weak, and strong) has its own characteristic range and characteristic interaction time which determine the likelihood that a given elementary particle reaction will occur. These characteristic properties vary over such a wide range among the three interactions that certain elementary particle reactions are overwhelmingly more likely to proceed via one interaction than the others. The probability that a certain reaction will occur via a given fundamental interaction may be expressed as a quantity called the “cross section.”

## 2. Characteristic Force Ranges

**2a. The Range of the Strong Interaction.** The strong interaction is a “short-range” force, responsible for the mutual attraction of nucleons within the nucleus. Because the nucleus is on the order of  $10^{-15}$  m in diameter, we infer that this is the approximate range of the strong interaction. The reason the strong interaction has such a short range is related to the fact that the quanta for this force field, the mesons, are particles with mass, unlike the electromagnetic field quanta (photons). It may be shown that the range of an interaction “mediated” by a massive particle is given approximately by:

$$\rho \simeq \frac{\hbar}{mc}, \quad (1)$$

where  $\rho$  is the characteristic range and  $m$  is the mass of the force field’s quanta. If we use the mass of the least massive meson, the pion, then  $m = 140 \text{ MeV}/c^2$ , and  $\rho$  may be calculated to be about  $1.4 \times 10^{-15}$  m.

<sup>1</sup>The gravitational interaction is so weak that its presence may be virtually ignored at the elementary particle level of interactions.

**2b. The Range of the Weak Interaction.** Newly acquired experimental data have established that the range of the weak interaction is roughly  $10^{-18}$  m. This number is the result of the observation of the intermediary of the weak interaction, the “intermediate vector boson.”<sup>2</sup> This weak interaction quantum has a mass of  $84 \text{ GeV}/c^2$ , which, using Eq. (1), produces a value for  $\rho$  of  $2.3 \times 10^{-18}$  m. This range is exceedingly small compared to the size of a nucleus, and is taken to be zero in most weak interaction calculations.

**2c. The Range of the Electromagnetic Interaction.** The range of the electromagnetic interaction is infinite; that is, it has no characteristic range. All charged particles may interact electromagnetically at any separation, although the interaction depends inversely on the square of the separation.

## 3. Characteristic Interaction Times

**3a. Characteristic Time for Strong Interactions.** The characteristic time for the strong interaction is approximately  $10^{-23}$  seconds. This can be seen by imagining the following “thought experiment.” Suppose two hadrons approach one another, moving at speeds comparable to the speed of light, i.e.  $\approx 10^8$  m/s. If the particles approach within  $10^{-15}$  m of each other, they will interact via the strong interaction. The amount of time that either particle spends near the other is thus approximately the time it takes for one particle to traverse a distance of  $10^{-15}$  m, i.e.  $10^{-23}$  s. From that little thought experiment you are led to conclude that whenever hadrons spend at least  $10^{-23}$  seconds within the range of their mutual strong interactions they will interact. If some unstable hadron decays into two or more particles via the strong interaction, e.g.

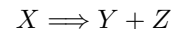

the mean lifetime of  $X$  is  $\approx 10^{-23}$  seconds. Thus when such a particle  $X$  is produced through some other interaction it doesn’t last very long.

**3b. Characteristic Time for Weak Interactions.** The characteristic times for weak interactions are from  $10^{-6}$  to  $10^{-10}$  seconds. These times are observed when unstable particles in nature decay via the weak interaction. For example, the  $\pi^+$  meson (a pion) is unstable and it usually

<sup>2</sup>For a more detailed account of the discovery of the vector boson see the “Science and Citizen” column of *Scientific American*, April 1983.

decays to an antimuon and a neutrino:

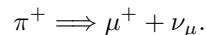

Occasionally it decays to a positron and a neutrino:

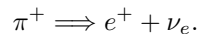

If the interaction that took the initial pion to the final group of particles was the strong interaction, the pion lifetime would be very short, about  $10^{-23}$  seconds. In that case a pion, even if it moved at the speed of light, would not travel more than  $10^{-15}$  meters before it decayed. In actuality, charged pions travel path lengths of several tens of centimeters before decaying, even when moving at low speeds.<sup>3</sup> The mean lifetime of the  $\pi^+$ , as determined by observing a great many particle decays, is  $2.6 \times 10^{-8}$  seconds hence it decays via the weak interaction. Although weak interactions can go no faster than  $10^{-10}$  seconds, they can go slower than the  $10^{-6}$  seconds we quoted above. Other factors may cause a weak interaction process to go more slowly. For example, the nucleus  $^{210}\text{Pb}$  is radioactive, and decays via the weak interaction with a half-life of about 22 years.

**3c. Characteristic Time of Electromagnetic Interactions.** The electromagnetic interaction has a characteristic time that falls somewhere between the strong and weak interaction times. Because the range of the electromagnetic interaction is not a sharply defined quantity, we cannot use the same simple model for calculating the interaction time that we used for the strong interaction. About all that we can say is that the electromagnetic interaction time is greater than  $10^{-21}$  seconds. We obtain this value by noting that the electromagnetic interaction is intrinsically about a hundred times weaker than the strong interaction. As an illustration of an electromagnetic interaction, the neutral pion,  $\pi^0$ , with a rest energy of 135 MeV, decays into two photons of total energy 135 MeV:

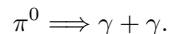

The mean lifetime for this decay is  $0.84 \times 10^{-16}$  seconds. Comparing this lifetime to the lifetime of the weakly decaying  $\pi^+$  ( $2.6 \times 10^{-8}$  seconds) illustrates the relative strengths of the electromagnetic and weak interactions. The characteristic time for electromagnetic interactions also depends on

<sup>3</sup>Charged particles can be observed by the tracks of bubbles they leave in a bubble chamber or by the trail of moisture droplets they leave in a cloud chamber.

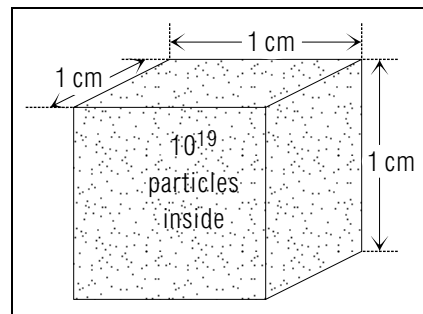

**Figure 1.** A simple model for an elementary particle collision target.

the size of the system involved, (e.g. an elementary particle, a nucleus, an atom, etc.). The lifetimes of elementary particles that decay via the electromagnetic interaction are typically between  $10^{-16}$  and  $10^{-21}$  seconds. Interactions such as  $A^* \Rightarrow A + \gamma$ , where  $A^*$  is an excited state of a nucleus or an atom and  $A$  is the nuclear or atomic ground state, also proceed via the electromagnetic interaction. The characteristic time for these processes is  $10^{-16}$  seconds or longer for nuclear decays and  $10^{-8}$  seconds or longer for atomic transitions.

## 4. Reaction Cross Sections

**4a. Introduction.** Aside from giving you an order of magnitude estimate of the relative strengths of the basic interactions, the characteristic time associated with a reaction is scientifically useful when you are dealing with decay reactions. However, for a reaction that is brought about by firing projectile particles at target particles a characteristic time is not readily measurable, and when you have it, it's not particularly informative. To determine whether a projectile particle and a target particle will interact, we must first calculate the collision probability as a function of target particle size and density. As a convenient model, consider the cubical system shown in Fig. 1, containing  $10^{19}$  target particles (for the time being, consider them as small spheres) randomly distributed throughout the cubical volume. Assume, for ease of computation, that when you "look into" this cubical region, the distribution of the particles is such that no particle in the box is obscured by another particle (no one particle is even partially behind another).<sup>4</sup> Suppose now that a projectile

<sup>4</sup>Of course, that assumption can't be made if the particles are "large enough" in extent, or if their number is large enough so that they are densely packed. For a dilute gas of small particles this assumption is reasonable.

particle is fired into this box in a direction normal to one of the cube faces. The probability that the projectile particle will hit a target particle is simply the ratio of the total effective cross-sectional area presented by the targets to the total area of the cube face.

**4b. Definition of Cross Sections.** The total effective target area associated with a given reaction is called the “cross section” for that reaction. The cross section for all possible reactions within the target can, in effect, be determined by direct measurement. The cross section so determined is the “total cross section,” related to the fraction of incident projectile particles that interact in any way with the target particles. This microscopic total cross section is completely analogous to your usual conceptions about the cross-sectional area presented by a target to a projectile. Less familiar is the cross section for an interaction to result in a specific outcome (such as, for example, the outcome where the incident and target particle disappear and two other specified particles result from the interaction). The total cross section is a measure of the probability of all possible reaction outcomes.

**4c. Flux of Particles.** The model developed in Sect. 4a is modified for real experiments, where the beams are generally smaller than the target face and “flux” is measured rather than numbers of particles. In our simple model, where the incident particles were fired randomly at the entire face of the container of target particles, the probability for interacting with the target particles was the ratio of the area presented by the target particles to the area  $A$  of the face of the container. In actual practice the incident particles are generally localized in a beam smaller in cross section than the target area, so the probability of striking a point on the target is not the same for every part of the target. Instead of the total number of particles incident on the target, you need to deal with the number of particles per unit area, thus taking account of the concentration of the beam. Also, the incident beam is generally a steady current of particles so you really measure currents of particles (particles per unit time) which emerge from the target. These two modifications of the counting of the projectile particles define a quantity called the “flux.” The flux of projectile particles is the number of projectile particles per second per unit cross-sectional area of the beam. The flux of particles that emerge unscathed from the other side of the target should then tell you about the total cross section.

**4d. Relation Between Flux and Cross Section.** The fractional change in flux due to projectile particles that interact in any way with

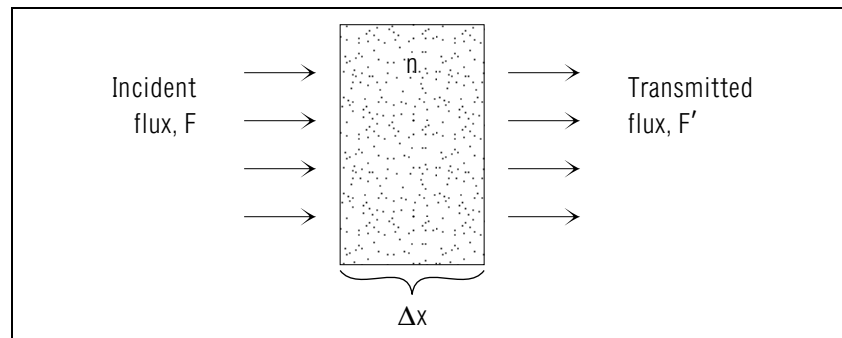

**Figure 2.** Attenuation of particle flux by a given thickness,  $\Delta x$ , of absorbing material in a target that has particle density  $n$ .

the target particles is directly related to the total cross section. Figure 2 shows a slab of target material, of cross-sectional area  $A$  and thickness  $\Delta x$ , containing  $N$  target particles.

A flux of projectile particles,  $F$ , is incident on the left side of the slab. Emerging unscathed from the right side of the slab is a smaller flux,  $F'$ , of projectile particles. The fractional number of particles that do interact is equal (for large numbers) to the probability that a projectile particle collides with a target particle, and is given by

$$\frac{F - F'}{F} = \frac{N\sigma}{A} \quad (2)$$

where  $\sigma$  is the total cross section for all possible reactions. We may express  $N/A$ , the number of target particles per unit area as

$$\frac{N}{A} = \frac{N\Delta x}{A\Delta x} = \frac{N\Delta x}{V} = n\Delta x \quad (3)$$

where we have used the fact that  $A\Delta x$  is the volume  $V$  of the target, and have defined  $n$  as the target particle density,  $N/V$ . The change in flux,  $\Delta F$ , is equal to  $F' - F$ , so we may express Eq. (2) as

$$\frac{\Delta F}{F} = -n\sigma\Delta x. \quad (4)$$

In the limit that  $\Delta x$  is infinitesimally small,  $\Delta F$  goes to  $dF$ , the infinitesimal change in the flux of the beam when passing through an infinitesimal thickness  $dx$  of target material. Integrating this expression as an indefinite

integral, we obtain

$$\int \frac{dF}{F} = - \int n\sigma dx \implies \ln F + C = -n\sigma x, \quad (5)$$

where  $C$  is a constant of integration obtained by applying the boundary conditions. When  $x$  is zero,  $F$  is equal to the initial flux, which we will call  $F_0$ . This condition, applied to Eq. (5), establishes  $C$  as  $-\ln F_0$ , so we may rearrange Eq. (5) and get

$$F = F_0 e^{-n\sigma x}, \quad (6)$$

the expression for the flux that gets through a thickness  $x$  of target material unscathed. Thus if we are given the incident and transmitted particle fluxes, and the target thickness and density, we can calculate the cross section for the scattering process.

### Acknowledgments

We would like to thank Professors Wayne Repko and Dan Stump for helpful discussions on some of the topics in this module. Preparation of this module was supported in part by the National Science Foundation, Division of Science Education Development and Research, through Grant #SED 74-20088 to Michigan State University.

### Glossary

- **cross section:** a measure of the probability of a given reaction between target particles and projectile particles, in terms of the total effective cross-sectional area of the target particles.
- **flux:** the number of projectile particles per unit time per unit cross-sectional area of a particle beam.
- **intermediate vector boson:** the particle that mediates the weak interaction.
- **total cross section:** a measure of the probability of all possible reactions between target particles and projectile particles, in terms of the total effective cross-sectional area of the target particles.

## PROBLEM SUPPLEMENT

1. Consider the target chamber described in Sect. 4a of the module text.
  - a. If each of the particles in the box has a “radius” of  $10^{-15}$  m, what fraction of the cross-sectional area of the box do these particles cover?
  - b. Suppose you fire point particles into the box. What is the probability that a projectile particle will come to within  $10^{-15}$  m of the center of any one of the target particles?
  - c. What is the probability that a projectile will come to within  $10^{-2}$  m of one of the target particles?
  - d. If all of the projectiles and targets are hadrons, what is the probability that a projectile comes within range of the strong interaction with one of the targets?
  - e. Suppose a burst of  $10^8$  projectile particles is fired into the box. How many of these can be expected to interact with the targets?
  - f. Suppose that in a sequence of five such bursts, the number of interactions observed in each “experiment” was: 35, 29, 32, 32, and 40. What conclusion can you draw from this “experimental” result?
2. Suppose that the projectile particles and the target particles described in Problem 1 interact only via the weak interaction. Since the weak interaction is less likely by a factor of about  $10^{-13}$ , how many of these  $1 \text{ cm}^3$  boxes should you place end-to-end, sending the beam through their length, for you to observe one weak interaction out of the  $10^8$  projectile particles?
3. Suppose we have a target chamber filled with iron nuclei of particle density  $8.4 \times 10^{28} \text{ m}^{-3}$ . If the thickness of iron nuclei needed to decrease an incident flux of neutrons by a factor of one half is 5 cm, what is the total cross section for all iron nuclei-neutron reactions?

**Brief Answers:**

1. a.  $\pi \times 10^{-7}$   
 b.  $\pi \times 10^{-7}$   
 c. 1 (certainty)  
 d.  $\pi \times 10^{-7}$   
 e.  $10\pi$   
 f. We can conclude that only the average number of interactions may be measured, and that this average will have some statistical uncertainty.
2.  $\approx 10^{12}$
3.  $1.65 \times 10^{-28} \text{ m}^2$

**MODEL EXAM**

1. See Output Skills K1-K3 on this module's *ID Sheet*.
2. A target chamber contains  $10^{23}$  hadronic particles. The dimensions of the face of the chamber are 5 cm by 8 cm. A beam of projectile particles is directed at the face of the chamber into the region containing the target particles.
  - a. If the particles of the beam are hadrons, approximately how many of  $10^{11}$  beam particles can you expect to undergo strong interactions with particles of the target? An order of magnitude answer is all that is asked here.
  - b. If the projectile particles interact with the target particles only via the weak interaction, how many beam particles need to be sent into the chamber for there to occur approximately one interaction between a beam particle and target particle?
  - c. If the density of target particles in a chamber is  $2.5 \times 10^{26} \text{ m}^{-3}$ , and if the thickness of target chamber needed to reduce the incident intensity to 1.0% of the original intensity is 8 cm, what is the total cross section for interaction of the beam particles with those of the target?

**Brief Answers:**

1. See this module's *text*.
2. a.  $10^7$   
 b.  $10^{17}$   
 c.  $2.3 \times 10^{-25} \text{ m}^2$

